

STAMFORD® | AvK®

HV 804 X WDG 81 - Technical Data Sheet

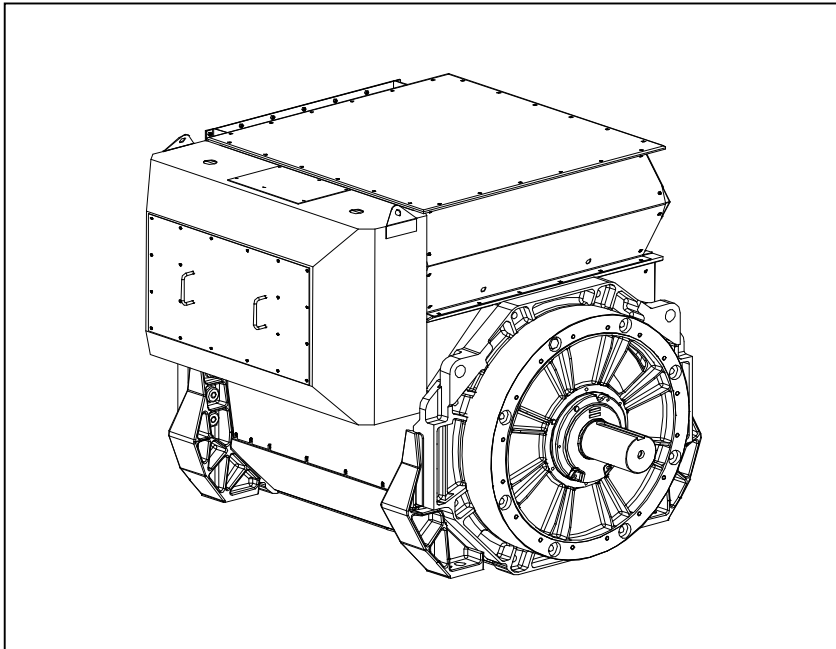

FRAME HV 804 X **STAMFORD | AvK**

SPECIFICATIONS & OPTIONS

STANDARDS

Cummins Generator Technologies industrial generators meet the requirements of BS EN 60034 and the relevant sections of other national and international standards such as BS5000, VDE 0530, NEMA MG1-32, IEC60034, CSA C22.2-100, AS1359.

Other standards and certifications can be considered on request.

DESCRIPTION

The STAMFORD PI range of synchronous ac generators are brushless with a rotating field. They are separately excited by the STAMFORD Permanent Magnet Generator (PMG). This is a shaft mounted, high frequency, pilot exciter which provides a constant supply of clean power via the Automatic Voltage Regulator (AVR) to the main exciter. The main exciter output is fed to the main rotor, through a full wave bridge rectifier, protected by surge suppression.

VOLTAGE REGULATORS

The P80 range generators complete with a PMG are available with one AVR. Underspeed protection (UFRO) is also provided by the AVR. The UFRO will reduce the generator output voltage proportional to the speed of the generator below a pre-settable level.

The STAMFORD | AvK Digital Excitation Control System (DM110) is an electronic, solid-state, microprocessor based control device. The DM110 regulates the output voltage of a the ac generator by controlling the current into the generator exciter field. Input power to the DM110 is provided by a multi-pole, high-frequency, permanent magnet generator (PMG).

The DM110 is supplied in an encapsulated package designed for behind-the-panel mounting. Front panel indicators (LEDs) annunciate DM110 status and system conditions. DM110 connections are made through quarterinch, quick-connect terminals on the rear panel. A 9-pin DB-9 type connector on the rear panel provides communication between the DM110 and an IBM compatible PC.

Technical details on the DM110 are available on the Stamford-AvK website using the following URL:
<https://www.stamford-avk.com/downloads/avr-manuals>

WINDINGS & ELECTRICAL PERFORMANCE

All generator stators are wound to 2/3 pitch. This eliminates triplen (3rd, 9th, 15th ...) harmonics on the voltage waveform and is found to be the optimum design for trouble-free supply of non-linear loads. The 2/3 pitch design avoids excessive neutral currents sometimes seen with higher winding pitches. A fully connected damper winding reduces oscillations during paralleling. This winding, with the 2/3 pitch and carefully selected pole and tooth designs, ensures very low levels of voltage waveform distortion.

TERMINALS & TERMINAL BOX

Standard generators feature a main stator with 6 ends brought out to the terminals, which are mounted on the frame at the non-drive end of the generator. A sheet steel terminal box contains the AVR and provides ample space for the customers' wiring and gland arrangements. It has removable panels for easy access.

SHAFT & KEYS

All generator rotors are dynamically balanced to better than BS6861:Part 1 Grade 2.5 for minimum vibration in operation. Two bearing generators are balanced with a half key.

INSULATION/IMPREGNATION

The insulation system is class 'F'. All wound components are impregnated with materials and processes designed specifically to provide the high build required for static windings and the high mechanical strength required for rotating components.

QUALITY ASSURANCE

Generators are manufactured using production procedures having a quality assurance level to BS EN ISO 9001.

NOTE ON REGULATION

The stated voltage regulation may not be maintained in the presence of certain radio transmitted signals. Any change in performance will fall within the limits of Criteria 'B' of EN 61000-6-2:2001. At no time will the steady-state voltage regulation exceed 2%.

NB Continuous development of our products entitles us to change specification details without notice, therefore they must not be regarded as binding.

FRAME HV 804 X WINDING 81

RATINGS		REFER TO SALES AND SERVICE BRIEFING	
MAXIMUM ALTITUDE		1000 METRES ABOVE SEA LEVEL	
MAXIMUM AMBIENT TEMPERATURE		40° C	
CONTROL SYSTEM SERIES 3		SEPARATELY EXCITED BY P.M.G.	
A.V.R.		FULL WAVE RECTIFIED	
VOLTAGE REGULATION		± 0.25%	
SUSTAINED SHORT CIRCUIT		REFER TO SHORT CIRCUIT DECREMENT CURVES OF THIS SECTION	
INSULATION SYSTEM		CLASS F	
PROTECTION		IP23 STANDARD	
RATED POWER FACTOR		0.8	
STATOR WINDING		DOUBLE LAYER LAP	
WINDING PITCH		2/3	
WINDING LEADS		6	
R.F.I. SUPPRESSION		BS EN 50081/2-1/2 VDE 0875G VDE 0875N For other standards apply to the factory	
WAVEFORM DISTORTION		NO LOAD < 1.5% NON-DISTORTING BALANCED LINEAR LOAD < 3.0%	
MAXIMUM OVERSPEED		2250 Rev/Min	
BEARING DRIVE END		ISO 6236 C3	
BEARING NON DRIVE END		ISO 6324 C3	
EFFICIENCY		REFER TO EFFICIENCY CURVES OF THIS SECTION	
FREQUENCY		50Hz	60Hz
TELEPHONE INTERFERENCE		THF< 2%	TIF<50
COOLING AIR		3.8 m ³ /sec	4.25 m ³ /sec
VOLTAGE STAR (Y)		10000	11400
kVA BASE RATING FOR REACTANCE VALUES		3724	4245
Xd DIRECT AXIS SYNCHRONOUS		1.950	2.150
X'd DIRECT AXIS TRANSIENT		0.157	0.165
X''d DIRECT AXIS SUB-TRANSIENT		0.115	0.121
Xq QUADRATURE AXIS REACTANCE		1.440	1.520
X''q QUAD. AXIS SUB-TRANSIENT		0.218	0.230
Xl LEAKAGE REACTANCE		0.079	0.083
X ₂ NEGATIVE PHASE SEQUENCE		0.167	0.176
X ₀ ZERO PHASE SEQUENCE		0.028	0.030
REACTANCES ARE SATURATED		VALUES ARE PER UNIT AT RATING AND VOLTAGE INDICATED	
T'd TRANSIENT TIME CONSTANT		0.228	
T''d SUB-TRANSIENT TIME CONSTANT		0.017	
T'do O.C. FIELD TIME CONSTANT		5.160	
T _a ARMATURE TIME CONSTANT		0.069	
SHORT CIRCUIT RATIO		1/Xd	
STATOR WINDING RESISTANCE (L-N)		0.19430	
ROTOR WINDING RESISTANCE		1.630	
EXCITER STATOR FIELD RESISTANCE		17.00	
EXCITER ROTOR RESISTANCE (L-L)		0.092	
PMG STATOR RESISTANCE (L-L)		3.800	
RESISTANCE VALUES ARE IN OHMS AT 20° C			
NO LOAD EXCITATION VOLTAGE		15.0	
FULL LOAD EXCITATION VOLTAGE		67.0	

Continuous development of our products entitles us to change specification details without notice, therefore they must not be regarded as binding.

FRAME HV 804 X WDG 81 50 Hz

THREE PHASE EFFICIENCY CURVES

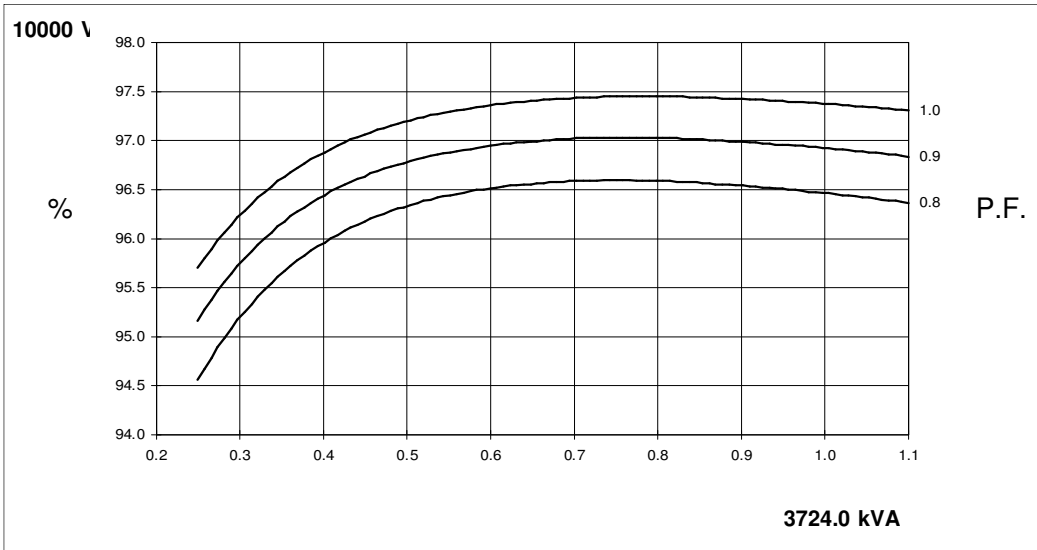

FRAME HV 804 X WDG 81 60 Hz

THREE PHASE EFFICIENCY CURVES

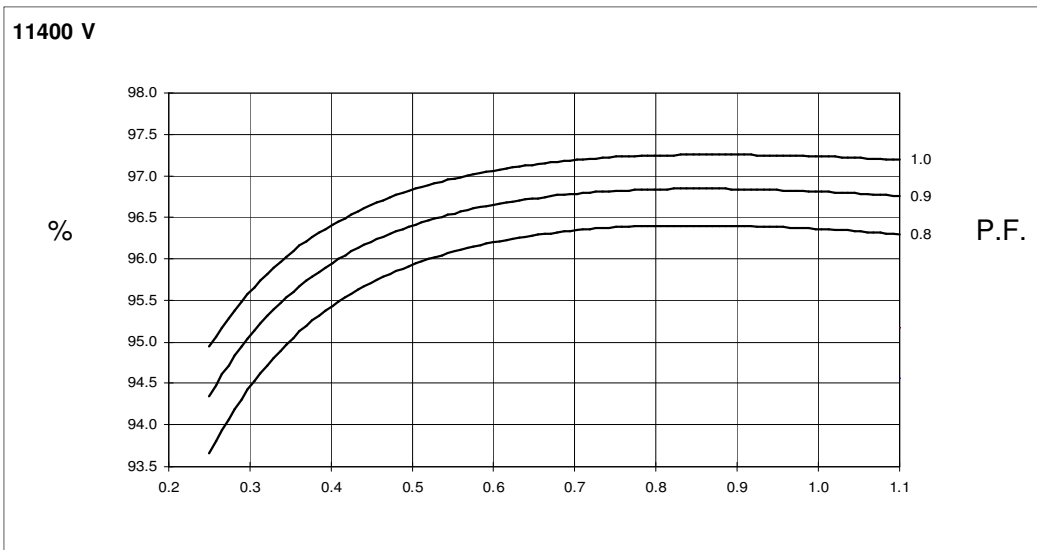

FULL WAVE RECTIFIED AVR
 LOCKED ROTOR MOTOR STARTING CURVE

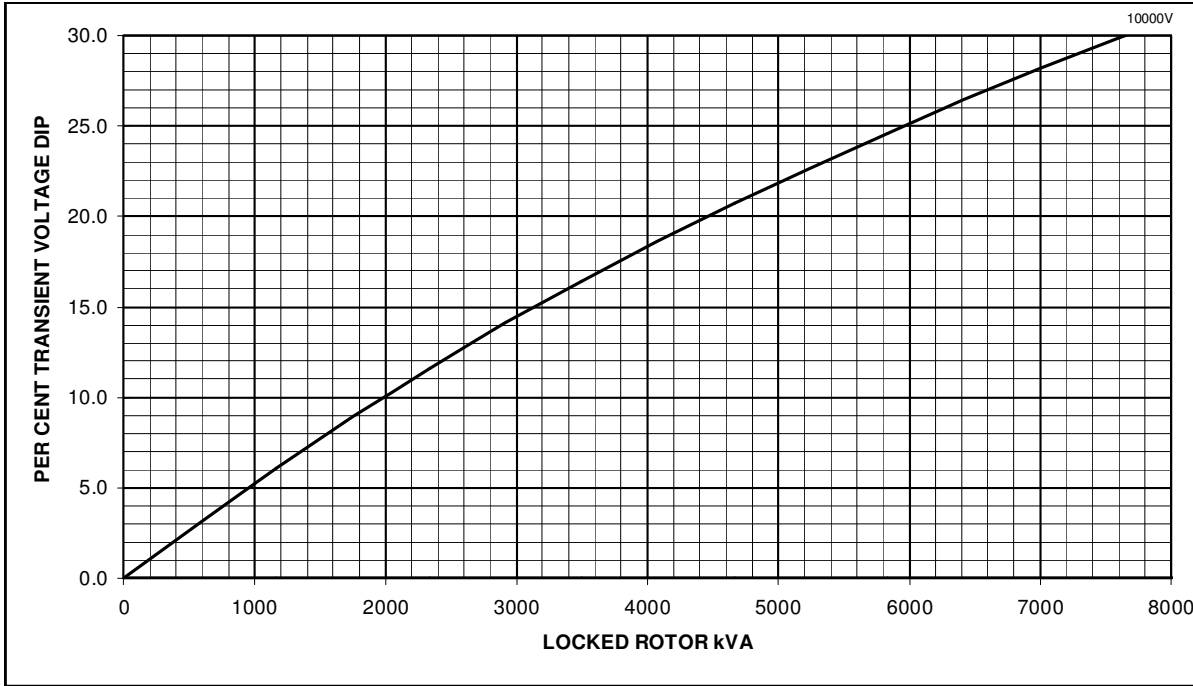

FRAME HV 804 X WDG 81 50Hz

Three Phase Short Circuit Decrement Curve
 No- Load Excitation at Rated Speed

Based on series star (wye) connection

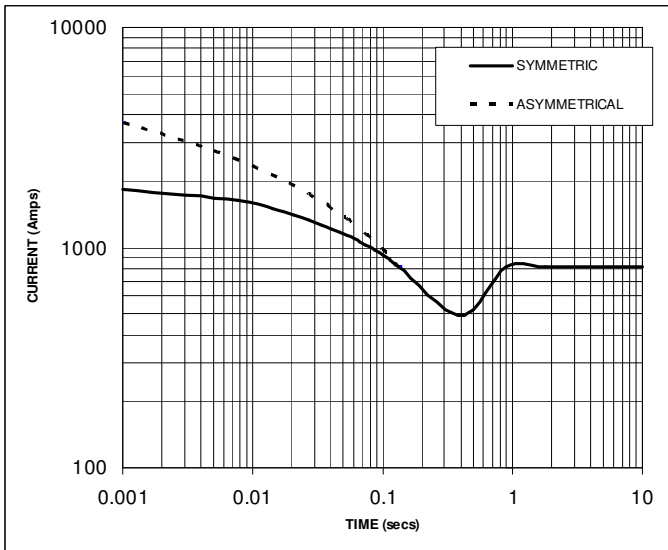

NOTE 1
 THE FOLLOWING MULTIPLICATION FACTORS SHOULD BE USED TO ADJUST THE VALUES FROM CURVES BETWEEN THE 0.001 SECONDS AND THE MINIMUM CURRENT POINT IN RESPECT OF NOMINAL OPERATING VOLTAGE

VOLTAGE	FACTOR
10000V	X 1.00

THE SUSTAINED CURRENT VALUE IS CONSTANT IRRESPECTIVE OF VOLTAGE LEVEL

NOTE 2
 THE FOLLOWING MULTIPLICATION FACTORS SHOULD BE USED TO CONVERT THE VALUES CALCULATED IN ACCORDANCE WITH NOTE 1 TO THOSE APPLICABLE TO THE VARIOUS TYPES OF SHORT CIRCUIT

	3 PHASE	2 PHASE L-L	1 PHASE L-N
INSTANTANEOUS	X 1.0	X 0.87	X 1.30
MINIMUM	X 1.0	X 1.80	X 3.20
SUSTAINED	X 1.0	X 1.50	X 2.50
MAX SUSTAINED DURATION	10 SEC	5 SEC	2 SEC

ALL OTHER TIMES ARE UNCHANGED

SUSTAINED SHORT CIRCUIT = 817 Amps

**FULL WAVE RECTIFIED AVR
LOCKED ROTOR MOTOR STARTING CURVE**

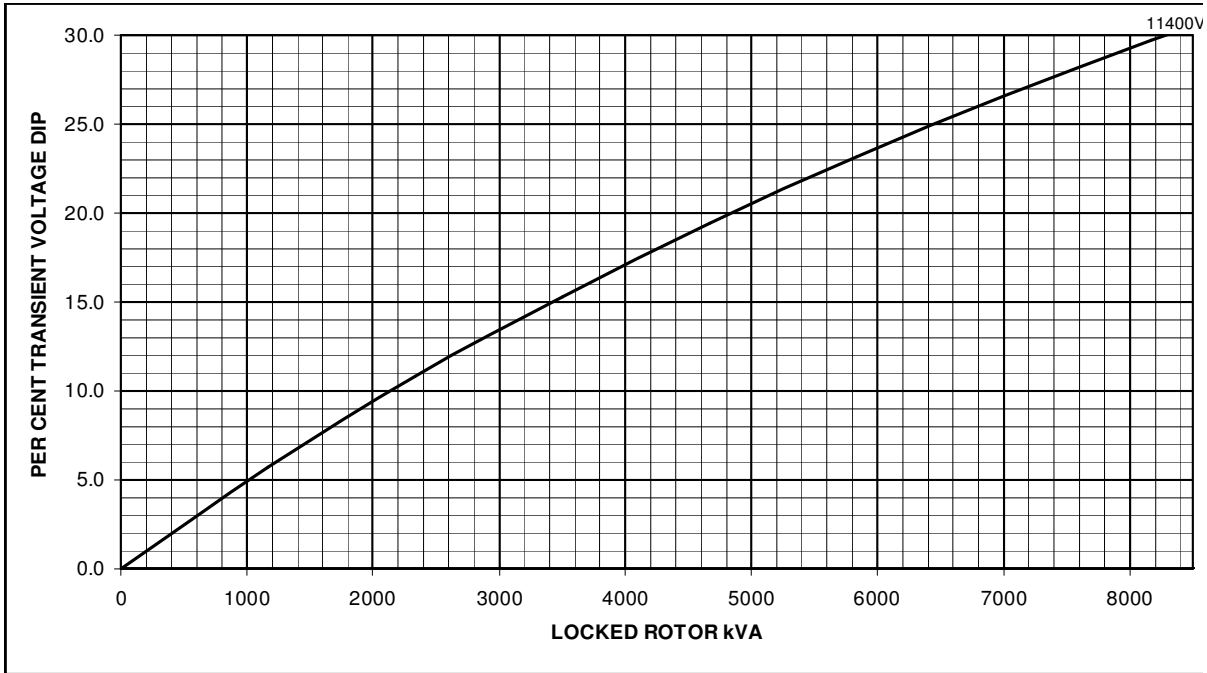

FRAME HV 804 X WDG 81 60Hz

**Three Phase Short Circuit Decrement Curve
No- Load Excitation at Rated Speed**

Based on series star (wye) connection

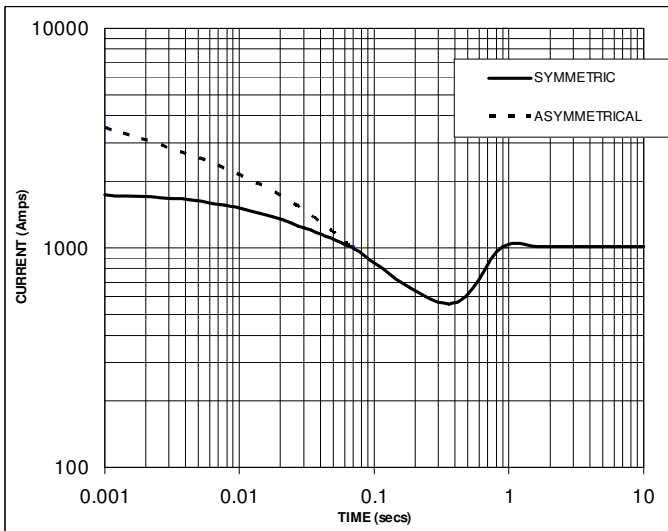

NOTE 1
THE FOLLOWING MULTIPLICATION FACTORS SHOULD BE USED TO ADJUST THE VALUES FROM CURVES BETWEEN THE 0.001 SECONDS AND THE MINIMUM CURRENT POINT IN RESPECT OF NOMINAL OPERATING VOLTAGE

VOLTAGE	FACTOR
11400V	X 1.00

THE SUSTAINED CURRENT VALUE IS CONSTANT IRRESPECTIVE OF VOLTAGE LEVEL

NOTE 2
THE FOLLOWING MULTIPLICATION FACTORS SHOULD BE USED TO CONVERT THE VALUES CALCULATED IN ACCORDANCE WITH NOTE 1 TO THOSE APPLICABLE TO THE VARIOUS TYPES OF SHORT CIRCUIT

	3 PHASE	2 PHASE L-L	1 PHASE L-N
INSTANTANEOUS	X 1.0	X 0.87	X 1.30
MINIMUM	X 1.0	X 1.80	X 3.20
SUSTAINED	X 1.0	X 1.50	X 2.50
MAX SUSTAINED DURATION	10 SEC	5 SEC	2 SEC

ALL OTHER TIMES ARE UNCHANGED

SUSTAINED SHORT CIRCUIT = 1010 Amps

